

Slim Medical Panel PC

ONYX-1731

ONYX-1731

17" Intel® Celeron J1900 Quad Core Processor
Slim Medical Panel PC

ONYX-1731 Manual
Jun., 2016

Copyright Notice

This document is copyrighted, 2016. All rights are reserved. The original manufacturer reserves the right to make improvements to the products described in this manual at any time without notice.

No part of this manual may be reproduced, copied, translated, or transmitted in any form or by any means without the prior written permission of the original manufacturer. Information provided in this manual is intended to be accurate and reliable. However, the original manufacturer assumes no responsibility for its use, nor for any infringements upon the rights of third parties, which may result from its use.

The material in this document is for product information only and is subject to change without notice. While reasonable efforts have been made in the preparation of this document to assure its accuracy, ONYX, assumes no liabilities resulting from errors or omissions in this document, or from the use of the information contained herein.

ONYX reserves the right to make changes in the product design without notice to its users.

Acknowledgments

- Intel® Celeron is a registered trademark of Intel® Corporation.
- Microsoft® Windows is a registered trademark of Microsoft® Corporation.

All other product names or trademarks are properties of their respective owners.

Packing List

Before you begin installing your Slim Medical Panel PC, please make sure that the following items have been shipped:

- ONYX-1731 Slim Medical Panel PC
- VESA Screws (M4 x 0.7 x 12mm)
- Utility DVD-ROM which contains , Drivers and Utilities
- Medical Power Adapter 60W/12V

If any of these items are missing or damaged, you should contact your distributor or sales representative immediately.

Headquarters

Onyx Healthcare Inc.

2F., No.135, Ln. 235, Baoqiao Rd., Xindian Dist.,

New Taipei City 231, Taiwan (R.O.C.)

TEL: +886-2-8919-2188

FAX: +886-2-8919-1699

E-mail: sales@onyx-healthcare.com

<http://www.onyx-healthcare.com>

Worldwide Offices:

Onyx Healthcare, USA Inc.

324W. Blueridge Ave., Orange,, CA 92865, USA

Tel : +1-714-792-0774

Fax: +1-714-792-0481

Slim Medical Panel PC

ONYX-1731

Email: usasales@onyx-healthcare.com

Onyx Healthcare EUROPE B.V.

Primulalaan 42, 5582 GL Waalre, Netherlands

Tel : +31-(0)499-745600

Email: eusales@onyx-healthcare.com

Onyx Healthcare (Shanghai) INC.

20F, unit D, GEM Building, No. 487 Tianlin Road,

Shanghai, China

Tel: +86-021-64956588

Fax: +86-021-64956889

Email: cnsales@onyx-healthcare.com

Safety & Warranty

1. Read these safety instructions carefully.
2. Keep this user's manual for later reference.
3. Disconnect this equipment from any AC outlet before cleaning.
Do not use liquid or spray detergents for cleaning. Use a damp cloth.
4. For pluggable equipment, the power outlet must be installed near the equipment and must be easily accessible.
5. Keep this equipment away from humidity.
6. Put this equipment on a reliable surface during installation.
Dropping it or letting it fall could cause damage.
7. The openings on the enclosure are for air convection. Protect the equipment from overheating. **DO NOT COVER THE OPENINGS.**
8. **Make sure the voltage of the power source is correct before connecting the equipment to the power outlet.**
9. Position the power cord so that people cannot step on it. Do not place anything over the power cord.
10. All cautions and warnings on the equipment should be noted.
11. If the equipment is not used for a long time, disconnect it from the power source to avoid damage by transient over-voltage.
12. Never pour any liquid into an opening. This could cause fire or electrical shock.
13. Never open the equipment. For safety reasons, only qualified

service personnel should open the equipment.

14. If any of the following situations arises, get the equipment checked by service personnel:

- a. The power cord or plug is damaged.
- b. Liquid has penetrated into the equipment.
- c. The equipment has been exposed to moisture.
- d. The equipment does not work well, or you cannot get it to work according to the users manual.
- e. The equipment has been dropped and damaged.
- f. The equipment has obvious signs of breakage.

15. DO NOT LEAVE THIS EQUIPMENT IN AN UNCONTROLLED ENVIRONMENT WHERE THE STORAGE TEMPERATURE IS BELOW -20° C (-4°F) OR ABOVE 60° C (140° F). IT MAY DAMAGE THE EQUIPMENT.

16. External equipment intended for connection to signal input/output or other connectors, shall comply with relevant UL / IEC standard (e.g. UL 60950-1 for IT equipment and ANSI/AAMI ES 60601-1 / IEC 60601-1 series for systems – shall comply with the standard IEC 60601-1-1, Safety requirements for medical electrical systems. Equipment not complying with ANSI/AAMI ES 60601-1 shall be kept outside the patient environment, as defined in the standard.)

17. WARNING: To avoid risk of electric shock, this equipment must only be connected to a supply mains with protective earth. (AVERTISSEMENT: Pour éviter tout risque de choc électrique, cet appareil doit être connecté à une alimentation secteur avec une prise de terre)

18. Warning: Do not modify this equipment without authorization of the manufacturer. (Avertissement: Ne pas

Slim Medical Panel PC

ONYX-1731

modifier cet équipement sans l'autorisation du fabricant)

Caution:

It may cause the danger of explosion if battery is incorrectly replaced. Replace only with same or equivalent type recommended by the manufacturer.

Classification

1. Degree of protection against electric shock: Not classified.
2. Degree of protection against the ingress of water: IPX0
3. Equipment not suitable for use in the presence of a flammable anesthetic mixture with air or with oxygen or nitrous oxide.
4. Mode of operation: Continuous
5. Type of protection against electric shock: Class I equipment
6. No Applied part, No AP / APG

FCC

Warning!



This device complies with Part 18 FCC Rules. Operation is subject to the following two conditions: (1) this device may not cause harmful interference, and (2) this device must accept any interference received including interference that may cause undesired operation.





UL Module Description



Onyx-1731 AC modules are developed to suitable for the Classification Mark requirement

Safety Symbol Description

The following safety symbols are the further explanations for your reference.

	<p><i>Medical equipment with respect to electric shock, fire and mechanical hazards only in accordance with ANSI/AAMI ES 60601-1: 2005 AND CAN/CSA-C22.2 No. 60601-1:08</i></p>
	<p>Attention, consult ACCOMPANYING DOCUMENTS.</p>
	<p><i>Stand-by (Green light)</i></p>
	<p>Ground wire Protective Ground wire.</p>
	<p><i>Medical equipment with respect to electric shock, fire and mechanical hazards only in accordance with UL 60601-1, and CAN/CSA C22.2 NO. 601.1</i></p>

Below Table for China RoHS Requirements
 產品中有毒有害物質或元素名稱及含量

ONYX Panel PC/ Workstation

部件名稱	有毒有害物質或元素					
	鉛 (Pb)	汞 (Hg)	鎘 (Cd)	六價鉻 (Cr(VI))	多溴聯苯 (PBB)	多溴二苯醚 (PBDE)
印刷電路板 及其電子元件	×	○	○	○	○	○
外部信號 連接器及線材	×	○	○	○	○	○
外殼	×	○	○	○	○	○
中央處理器 與記憶體	×	○	○	○	○	○
硬碟	×	○	○	○	○	○
液晶模組	×	○	○	○	○	○
光碟機	×	○	○	○	○	○
觸控模組	×	○	○	○	○	○
電源	×	○	○	○	○	○

O: 表示該有毒有害物質在該部件所有均質材料中的含量均在
 SJ/T 11363-2006 標準規定的限量要求以下。

X: 表示該有毒有害物質至少在該部件的某一均質材料中的含量超出
 SJ/T 11363-2006 標準規定的限量要求。

備註:

- 一、此產品所標示之環保使用期限，系指在一般正常使用狀況下。
- 二、上述部件物質中央處理器、記憶體、硬碟、光碟機、觸控模組為選購品。

Contents

Chapter 1 General Information

1.1 Introduction.....	1-1
1.2 Features	1-2
1.3 Specification	1-3
1.4 Dimension	1-7

Chapter 2 Hardware Installation

2.1 Safety Precautions	2-1
2.2 A Quick Tour of the ONYX-1731	2-2
2.3 VESA Mounting Holes.....	2-4

Chapter 3 Driver Installation

3.1 Installation	3-3
------------------------	-----

Appendix A Miscellanea

A.1 General Cleaning Tips.....	A-2
A.2 Cleaning Tools	A-3
A.3 Scrap Computer Recycling	A-5

Chapter

1

**General
Information**

1.1 Introduction

The ONYX-1731 is a Slim Medical Panel PC with Intel® Celeron J1900 Quad Core processor-based computer that is designed to serve as a point of care station. It is a PC-based system with 17" true color TFT LCD display, Zero Noise solution; integrated multimedia functions make them the perfect platforms to build comprehensive lifestyle computing applications.

The ONYX-1731 includes all the features of a powerful computer into a slim and attractive chassis. ONYX-1731 has 350 nits TFT displays with 1280 x 1024 resolution. It supports 2.5" Hard Disk Drive storage and one Mini Card slot for WLAN expansion. Moreover, they feature flexible I/O ports, such as four USB 2.0, one isolated RS-232 and two isolated Gigabit LANs.

Convenient operation, Silent, compact, mobility and highly integrated multimedia system let you to focus on healthcare utility, interactive information displays, automation control systems, general desktop usage, multimedia recreation, and other medical requirements.

1.2 Features

- 17" SXGA TFT LCD Display
- Easy To Use, Compact, Simple Design
- Fanless, Zero Noise
- 1000 : 1 Contrast Wide View Angle
- 350 nits High Brightness
- Intel® Celeron J1900 Processor
- Resistive Touch screen
- 802.11 a/b/g/n Wireless LAN (Optional)
- Weight: 5.3 Kg, Thickness: 69 mm

1.3 Specification

Hardware Specifications

Display	17" SXGA TFT LCD
CPU	Intel® Celeron J1900 Quad Core Processor
System Memory	204-pin DDR3 SODIMM x 2, Max. 8GB
Storage Drive	2.5" HDD/SSD (SATA), Slim DVD Drive(SATA)
Expansion	Mini-Card x 1
Function Button	Power On/Off, LCD Brightness Up/Down, Speaker Volume Up/Down
I/O	USB 2.0 x 4 Isolated RS-232 x 1 Isolated Gigabit LAN x 2 Line-out, Mic VGA out x 1 Equipotential Terminal
Security	Smart Card Reader(optional), RFID Reader(optional)
Power Requirement	DC 12~24V

LCD Specifications

Model	AUO G170ETN01.0
Display Type	17" color TFT LCD
Max. Resolution	1280 x 1024
Max. Colors	16.7M
Dot Size (mm)	0.264 x 0.264

Luminance (cd/m²)	350 (TYP)
Viewing Angle	170°(H)
	160°(V)
Contrast Ratio	1000 : 1
Brightness Control	Yes
Back Light Life Time	30,000 Hrs

Note: All ONYX's LCD products are manufactured with High precision technology. However, there are a small number of defective pixels in all LCD panels that are not able to change color. This is a normal occurrence for all LCD displays from all manufacturers and should not be noticeable or objectionable under normal operation. ONYX LCD panels are qualified for industry standard conditions in the following: total 7 dead pixels on a screen or if there are 3 within 1 inch square area of each other on the display.

Mechanical Specifications

Architecture	Close-frame
Front Bezel	Plastic bezel with resistive touch screen
Color	White
Mounting / Holder	VESA 75/100mm, Screw type: M4*8mm
Construction	3mm ABS + PC TYPE Plastic housing
Dimension (W x H x D)	15.1" x 13.6" x 2.7" (384mm x 345mm x 69mm)
Net Weight	11.7lb(5.3 kg)
Gross Weight	20.5lb(9.3 kg)

Power Supply Specifications

Model	Adapter ATM065-P120
Input Voltage	100-240V AC, 2-1A @ 50-60 Hz
Output Voltage	12V, 5A, 60W max.

Environmental Specifications

Operating Temperature	10°C to 40°C (50°F ~104°F)
Operating Humidity	5% to 95% RH non-condensing
Storage Temperature	-20°C to 60°C (-4°F ~140°F)
Storage Humidity	10% to 90%@ 40°C, non-condensing
Vibration	0.5G / 5 ~ 500Hz (Random) / operation
Shock	15G peak acceleration (11 msec. duration) / operation
Drop	76cm (1 Corner, 3 Edge, 6 Surface)
EMI / Safety	CE / FCC Class B/ EN 60601-1
Noise	Zero noise

TouchScreen

Type	5-wire, Analog Resistive
Interface	USB Interface
Resolution	2048 x 2048
Light Transmission	> 80% ± 2%
Life Time	35 million times

1.4 Dimension

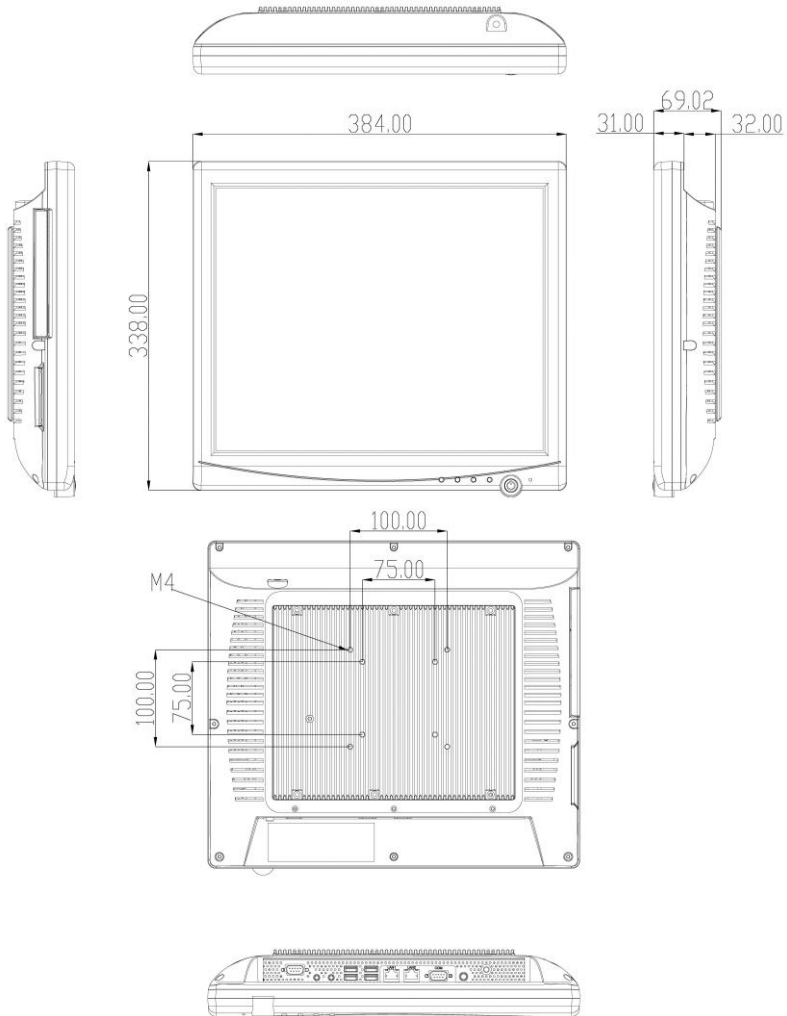

Unit: mm

Slim Medical Panel PC

ONYX-1731

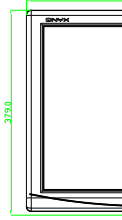
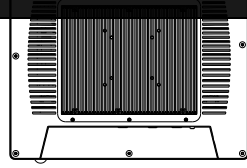

Chapter

2

Hardware Installation

2.1 Safety Precautions

Warning!



Always completely disconnect the power cord from your board whenever you are working on it. Do not make connections while the power is on, because a sudden rush of power can damage sensitive electronic components.

Do not make connections while the power is on, because a sudden rush of power can damage sensitive electronic components.

To avoid risk of electric shock, this equipment must only be connected to a supply mains with protective earth”

Do not modify this equipment without authorization of the manufacturer.

Caution!



Always ground yourself to remove any static charge before touching the board. Modern electronic devices are very sensitive to static electric charges. Use a grounding wrist strap at all times. Place all electronic components on a static-dissipative surface or in a static-shielded bag when they are not in the chassis

2.2 Quick Tour of ONYX-1731

There are 5 control buttons in the front side of ONYX-1731. Please refer to table 2.1 for the function of each button.



Control Buttons

Picture 2.1: Front View of ONYX-1731



Control Button	Function
	Power On/Off
	Increase LCD brightness
	Decrease LCD brightness
	Increase speaker volume Hardware volume control - does not associate with Windows volume bar
	Decrease speaker volume Hardware volume control - does not associate with Windows volume bar

Table 2.1: Functions of Control Buttons

The sunken I/O section is at the bottom, as shown in Picture 2.2.

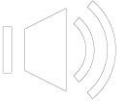
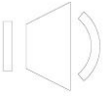
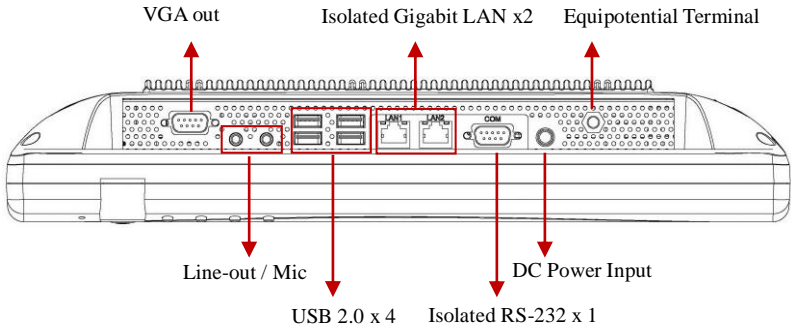

Picture 2.2: Bottom View of ONYX-1731

2.3 Mounting with VESA Holes

ONYX-1731 can be mounted with 75mm x 75mm or 100mm x 100mm VESA holes in the rear cover by wall-mount or desktop stand. Please use M4 x 0.7 x 12mm screws.

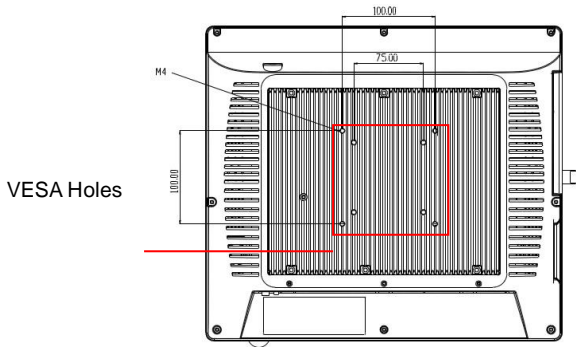

Picture 2.3: Back View of ONYX-1731

Chapter

3

Driver Installation

There are several installation ways depending on the driver package under different Operating Systems.

Please follow the sequence below to install the drivers:

For Windows 7/8.1:

Step 1 – Chipset Driver

Step 2 – Graphics Driver

Step 3 – LAN Driver

Step 4 – Audio Driver

Step 5 – USB 3.0 Driver

Step 6 – Resistive Touch Screen Driver

Step 7 – TPM Driver

For Windows 10:

Step 1 – Chipset Driver

Step 2 – Graphics Driver

Step 3 – Audio Driver

Step 4 – MBI Driver

Step 5 – TXE Driver

Step 6 – TPM Driver

Step 7 – Resistive Touch Screen Driver

Appendix

A

Miscellanea

A.1 General Cleaning Tips

You may need the following precautions before you begin to clean the computer. When you clean any single part or component for the computer, please read and understand the details below fully.

1. Be cautious of the tiny removable components when you use a vacuum cleaner to absorb the dirt on the floor.
2. Turn the system off before you start to clean the component or computer.
3. Never drop the components inside the computer or get circuit board damp or wet.
4. Be cautious of all kinds of cleaning solvents or chemicals when you use it for the sake of cleaning. Some individuals may be allergic to the ingredients.
5. Try not to put any food, drink or cigarette around the computer.
6. ONYX Healthcare Inc. has tested and verified these cleaning disinfectants: CIDEX, Viraguard, Control III Disinfectant Germicide, Caviwipes, Dispatch Disinfectant Cleaner CLH69101, Puregreen 24 Disinfectant, can be used with ONYX-1731. Use of any other disinfectants will void the warranty. These cleaning disinfectants should be applied with a cloth or wipe, not sprayed directly on the computer. After disinfecting, it is recommended to

thoroughly dry the Onyx-1731 with a lint-free cloth.

Note: We strongly recommend that you should shut down the system and remove the power cord before cleaning ONYX-1731.

A.2 Cleaning Tools

Although many companies have created products to help improve the process of cleaning your computer and peripherals users can also use household items to clean their computers and peripherals. Below is a listing of items you may need or want to use while cleaning your computer or computer peripherals.

Keep in mind that some components in your computer may only be able to be cleaned using a product designed for cleaning that component, if this is the case it will be mentioned in the cleaning tips.

- **Cloth** - A piece of cloth is the best tool to use when rubbing up a component. Although paper towels or tissues can be used on most hardware as well, we still recommend you to rub it with a piece of cloth.
- **Water or rubbing alcohol** – You may moisten a piece of cloth a bit with some water or rubbing alcohol and rub it on the computer. Unknown solvents may be harmful to the plastics parts.
- **Vacuum cleaner** - Absorb the dust, dirt, hair, cigarette particles, and other particles out of a computer can be one of the best methods of cleaning a computer. Over time these items can restrict the airflow in a computer and cause circuitry to corrode.

- **Cotton swabs** - Cotton swaps moistened with rubbing alcohol or water are excellent tools for wiping hard to reach areas in your keyboard, mouse, and other locations.
- **Foam swabs** - Whenever possible it is better to use lint free swabs such as foam swabs.

Note:

We strongly recommended that you should shut down the system before you start to clean any single components.

Please follow the steps below.

1. Close all application programs
2. Close operating software
3. Turn off power switch
4. Remove all device
5. Pull out power cable

A.3 Scrap Computer Recycling

If the computer equipments need the maintenance or are beyond repair, we strongly recommended that you should inform us as soon as possible for the suitable solution. For the computers that are no longer useful or work well, please contact with worldwide distributors for recycling.

The worldwide distributors show on the following website:

<http://www.onyx-healthcare.com.tw/Contact.php>

Note:

Follow the national requirements to dispose unit